

APRESENTAÇÃO DE PRODUTO 2024
PISOS LAMINADOS E VINÍLICOS



Um forte foco na **qualidade** e uma sede insaciável **por inovação**: esses são os motores que fazem da Quick-Step um dos protagonistas na indústria dos pisos. Descubra os interesses da marca e como ela evoluiu a partir de uma alternativa acessível à madeira para uma categoria por direito próprio.

EXCELÊNCIA EUROPEIA PRODUZIDA NO BRAZIL.





HISTÓRIA



1990

MARCA QUICK-STEP

Criou-se a marca Quick-Step. A **Unilin foi a primeira empresa a introduzir pisos laminados** no mercado belga com marca própria.

1997

UNICLIC

1ª Empresa a produzir pisos laminados com sistema de clic. **A Unilin é inventora desse sistema de encaixe clic.**

2012

UNILIN ARAUCO

A Arauco e a Unilin formaram uma Joint Venture, a Unilin Arauco Pisos Ltda. A empresa atua no segmento de pisos laminados de **alta resistência com as marcas Floorest e Quick-Step®**, que reúnem o que há de mais moderno em termos de tecnologia e design.

2017

INVESTIMENTOS NA FÁBRICA DO BRASIL

Os **produtos Floorest foram incorporados a marca Quick-Step**, que consolida-se no Brasil com a mais avançada tecnologia em pisos laminados e vinílicos, acabamentos além de muito design e inovação.

Com investimentos em nossa fábrica no Brasil, a Quick-Step aposta em qualidade de nível internacional, competitividade e resultados de venda incomparáveis.

2018

PISOS LAMINADOS RESISTENTES À ÁGUA

A Quick-Step é a **primeira empresa de pisos laminados a fabricar no Brasil** duas linhas de pisos laminados **resistentes à água. VISION e ELIGNA WIDE**

2019

4 LINHAS DE PISOS LAMINADOS RESISTENTES À ÁGUA

Quick-Step acrescenta mais uma linha de **pisos laminados a fabricar no Brasil** com **resistentes à água. A linha SMART**



2020



INVESTIMENTOS NA FÁBRICA DO BRASIL

Sem medo de ousar e com uma visão estratégica apurada, demos um passo importante em direção ao futuro com **a aquisição da Arauco desta joint venture.**

Assim foi criada a Unilin do Brasil, uma empresa pronta para explorar todo o seu potencial no mercado nacional com foco em **produtos de valor agregado sob a marca Quick-Step.**

2022

REFERÊNCIA EM LAMINADOS AMPLIA A GAMA DE PRODUTOS VINÍLICOS

Em busca de se tornar **referência em pisos quentes,** a Quick-Step lança uma grande coleção de vinílicos, 5 linhas com 44 cores.

Vinílicos rígidos e vinílicos flexíveis.

2023

INCLUSÃO DE MAIS UMA LINHA DE LAMINADOS RESISTENTES À ÁGUA

Agora com a linha Classic são **6 linhas,** sendo **5 com resistência à água** com uma seleção equilibrada de cores e estilos para uma aparência moderna e natural.

2024

AUMENTO NO TEMPO DE EXPOSIÇÃO À ÁGUA PARA LINHA DE LAMINADOS.

As 5 coleções de laminado resistentes à água tem novo tempo de exposição à água. Variando de **48 h até 100h.**



PISOS LAMINADOS

Qualidade superior e beleza
sem igual

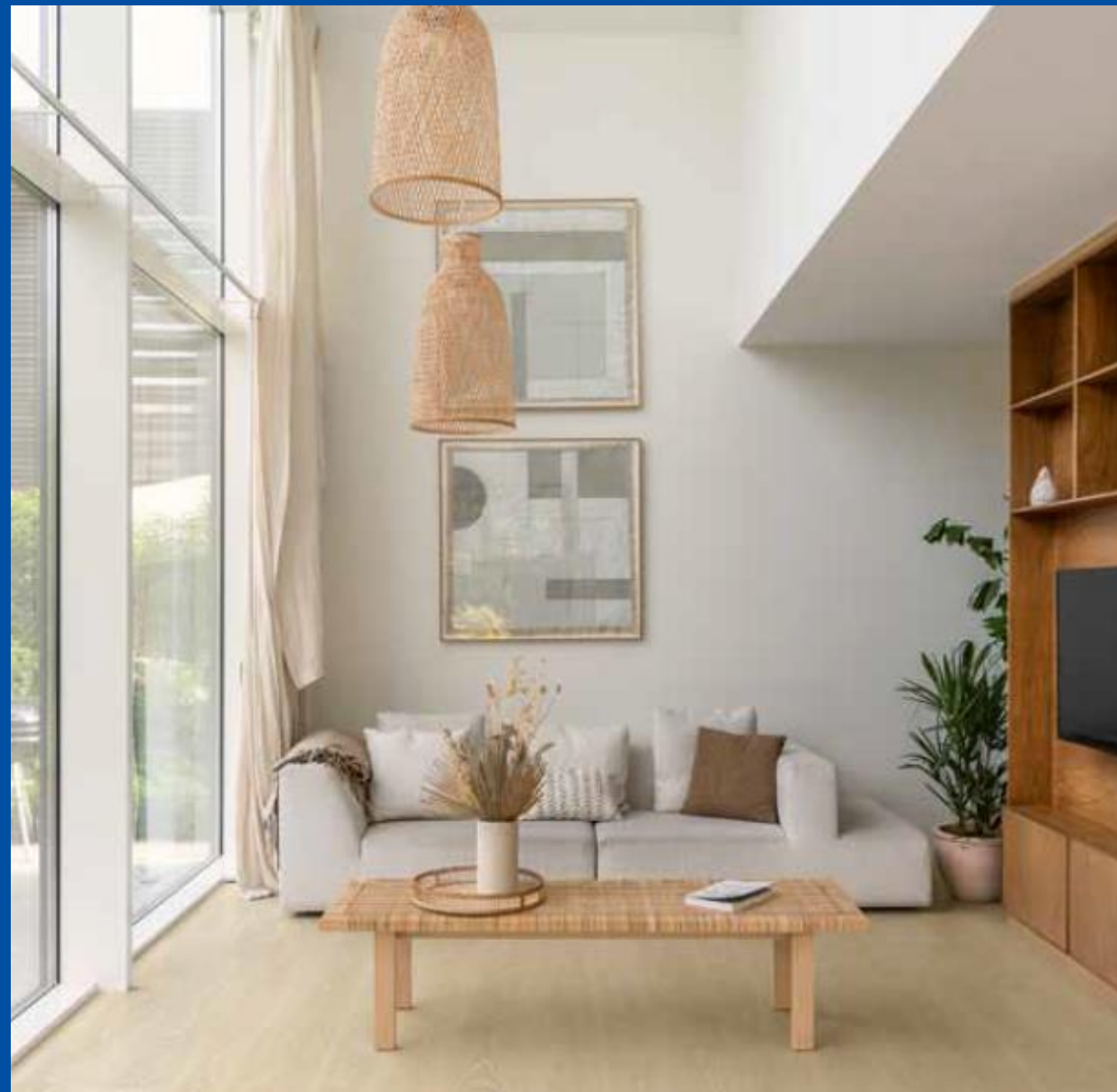



COMPOSIÇÃO DO PRODUTO



COMPOSIÇÃO DO PISO LAMINADO QUICK-STEP

O piso laminado é um piso composto por camadas construído em torno de uma placa de **Fibra de Alta Densidade (HDF)**. Todos os pisos laminados Quick-Step consistem em quatro camadas diferentes:



1. Uma sobreposição **transparente e resistente ao desgaste** que proporciona proteção contra manchas, impactos, arranhões, queimaduras e químicos domésticos.

2. Uma camada de **design: uma fotografia em alta resolução da madeira** ou lajes reais é reproduzida com sofisticadas técnicas de impressão, dispondo ainda de um acabamento com resina melamínica.

3. Uma **placa nuclear de HDF** colada e extremamente resistente e estável.

4. Uma **camada extra** que assegura ao piso estabilidade e o mantém reto, não permitindo que se deforme ou curve em boas condições de instalação e manutenção.

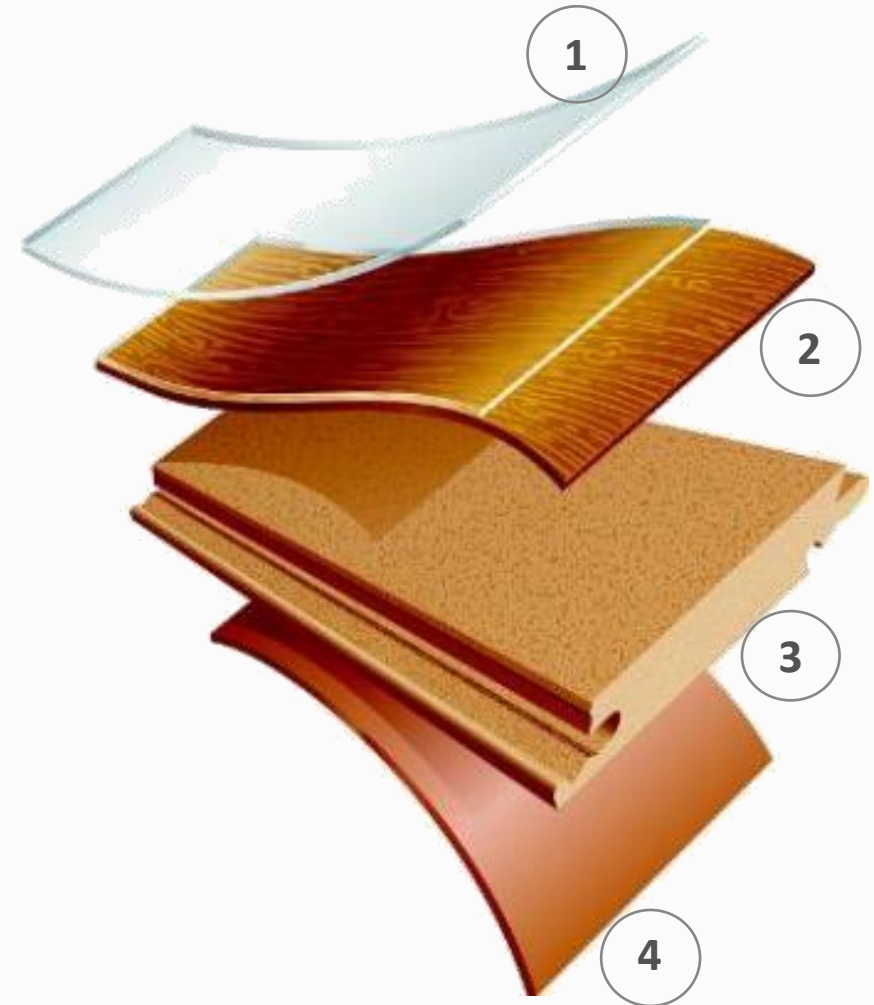

https://www.youtube.com/watch?v=-U_ATIqumM4



NOSSOS DIFERENCIAIS



Pisos a partir de **tecnologias exclusivas** que garantem mais qualidade, praticidade, beleza e durabilidade.

<https://www.youtube.com/watch?v=o55Q1QeW4A4>





À ÁGUA

RESISTÊNCIA

Conheça a tecnologia Hydroseal que deixa seu piso inteiramente impermeável.



A MANCHAS

RESISTÊNCIA

Um piso que resiste a manchas sem perder o brilho. Teste aqui!

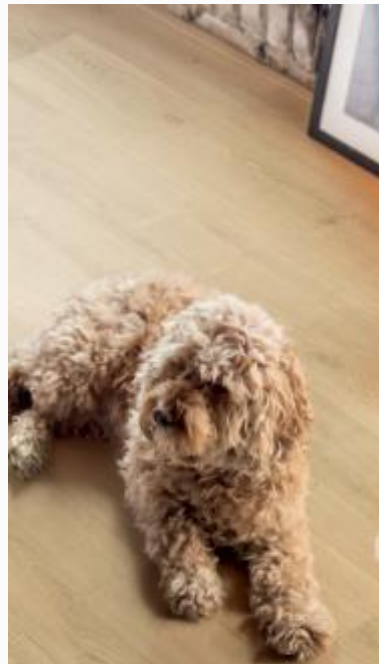

A RISCOS

RESISTÊNCIA

Feito para suportar tudo o que a vida jogar em cima deles. Experimente!



Veja como funciona o sistema Uniclic que garante uma instalação simples e fácil.

UNICLIC
SISTEMA UNICLIC

INSTALAÇÃO

ACESSE O VÍDEO PELO QR CODE.



ACESSE O VÍDEO PELO QR CODE.



ACESSE O VÍDEO PELO QR CODE.



ACESSE O VÍDEO PELO QR CODE.





OS DETALHES QUE
FAZEM A DIFERENÇA



Cada piso laminado tem a sua própria história, aparência e sensação ao toque. Os designers da Quick-Step escolhem com **cuidado a estrutura, o tratamento, o acabamento e o chanfro de cada piso**, em perfeita sintonia com as características de cada um dos designs.



Estrutura de madeira natural



Textura de acabamento em **que os veios, nós e fendas são visíveis no design.**



Estrutura de madeira intensa



Uma estrutura distinta que apresenta níveis **variados de profundidade e brilho, acentuando os nós e as fendas.**



Tratamento Serrado



Este efeito dá a **impressão da aspereza da madeira serrada** graças aos cortes de serra visíveis e perceptíveis.



Tratamento Raspado



Um tratamento de superfície com **efeito de raspado à mão**, que proporciona um acabamento artesanal ao seu piso.



Chanfro genuíno



O chanfro combina perfeitamente com as características do piso.
A cor, o design e a estrutura da régua são visíveis também ao longo do chanfro.



Chanfro Impression



Um efeito que dá a impressão de chanfros e confere ao piso a aparência de régua autênticas.





COLEÇÃO LAMINADO 2024



Coleção 2024 - Laminado

COLEÇÕES			DIMENSÕES	EMBALAGEM	CHANFRO	CLASSE	INSTALAÇÃO	GARANTIA
		IMPRESSIVE	 1380 x 190 x 8 mm	7 réguas = 1,84 m ²		AC 4		<ul style="list-style-type: none"> ✓ 25 ANOS USO RESIDENCIAL ✓ 5 ANOS USO COMERCIAL ✓ 15 ANOS ÁREAS MOLHÁVEIS*
		VISION	 1800 x 215 x 8 mm	7 réguas = 2,71 m ²		AC 5		<ul style="list-style-type: none"> ✓ 25 ANOS USO RESIDENCIAL ✓ 5 ANOS USO COMERCIAL ✓ 5 ANOS ÁREAS MOLHÁVEIS*
		ELIGNA WIDE	 1355 x 190 x 8 mm	8 réguas = 2,06 m ²		AC 4		<ul style="list-style-type: none"> ✓ 25 ANOS USO RESIDENCIAL ✓ 5 ANOS USO COMERCIAL ✓ 5 ANOS ÁREAS MOLHÁVEIS*
		CLASSIC	 1200 x 190 x 8 mm	9 réguas = 2,05 m ²		AC 4		<ul style="list-style-type: none"> ✓ 25 ANOS USO RESIDENCIAL ✓ 5 ANOS USO COMERCIAL ✓ 5 ANOS ÁREAS MOLHÁVEIS*
		SMART	 1200 x 190 x 7 mm	11 réguas = 2,51 m ²		AC 4		<ul style="list-style-type: none"> ✓ 20 ANOS USO RESIDENCIAL ✓ 5 ANOS USO COMERCIAL ✓ 5 ANOS ÁREAS MOLHÁVEIS*
		PREMIERE +	1200 x 215 x 7 mm	11 réguas = 2,84 m ²		AC 4		<ul style="list-style-type: none"> ✓ 18 ANOS USO RESIDENCIAL ✓ 5 ANOS USO COMERCIAL



IMPRESSIVE

Uma coleção de pisos laminados de tamanho médio, resistentes à água e com aparência e sensação ao toque excepcionalmente naturais*.

- ✓ 25 ANOS USO RESIDENCIAL
- ✓ 5 ANOS USO COMERCIAL
- ✓ 15 ANOS ÁREAS MOLHÁVEIS



IMPRESSIVE

1380 x 190 x 8 mm - Embalagem 7 réguas = 1,84 m²

CHANFRO 

UNICLIC
PARQUÊ LAMINADO

CLASSE AC4





Carvalho Clássico Natural
IM 1848



Carvalho Marron Acinzentado
IM 1850



Carvalho Suave Médio
IM 1856



Carvalho Natural Soft
IM 1855



Carvalho Bege Serrado
IM 1857



Carvalho Cinza Suave
IM 3558



VISION

A linha Vision apresenta grande variedade de tonalidades.
Maior resistência em ambientes de diferentes estilos*.

- ✓ 25 ANOS USO RESIDENCIAL
- ✓ 5 ANOS USO COMERCIAL
- ✓ 5 ANOS ÁREAS MOLHÁVEIS



VISION

1800 x 215 x 8 mm - Embalagem 7 réguas = 2,71 m²

CHANFRO 0



CLASSE ACS



Carvalho Semino
FVW 851



Carvalho Andes
FVW 866



Carvalho Cubano
FVW 877



Carvalho Victoriano
FVW 1462



Carvalho Studio
FVW 1463



Carvalho Agrade
FVW 1464



Carvalho Pietis
FVW 1611



Cumaru Telé
FVW 1666



ELIGNA WIDE

Réguas médias com 8 mm de espessura, com design de madeira intensa. O chanfro Impression complementa o design*.

- ✓ 25 ANOS USO RESIDENCIAL
- ✓ 5 ANOS USO COMERCIAL
- ✓ 5 ANOS ÁREAS MOLHÁVEIS



ELIGNA WIDE

1355 x 190 x 8 mm - Embalagem 8 réguas = 2,06 m²

CHANFRO 

 UNICLIC

CLASSE AC4

08W3677



Carvalho Claro Semrado
QSEW 3676



Carvalho Natural Semrado
QSEW 3677



Carvalho Deserto Restaurado
QSEW 3678



Carvalho Café Restaurado
QSEW 3679



Carvalho Acinzentado
com Cortes de Seima
QSEW 3680



Castanheiro Natural
Restaurado
QSEW 3784



Castanheiro Escuro
Restaurado
QSEW 3785



Castanheiro Antigo
Restaurado
QSEW 3786



CLASSIC

Combina resistência à água com uma seleção equilibrada de cores e estilos para uma aparência moderna e natural.

- ✓ 25 ANOS USO RESIDENCIAL
- ✓ 5 ANOS USO COMERCIAL
- ✓ 5 ANOS ÁREAS MOLHÁVEIS



CLASSIC

1200 x 190 x 8 mm - Embalagem 9 réguas = 2,05 m²

CHANFRO 

UNICLIC 

CLASSE AC4





Carvalho Biscoito Marrom
CLM 5794



Carvalho Nebilina Cinza
CLM 5795



Carvalho Congelado Bege
CLM 5799



Teca Marrom Médio
CLM 5803



SMART

Réguas com 7 mm de espessura, com uma gama ampla de cores e várias opções de designs*.

- ✓ 20 ANOS USO RESIDENCIAL
- ✓ 5 ANOS USO COMERCIAL
- ✓ 5 ANOS ÁREAS MOLHÁVEIS



SMART

1200 x 190 x 7 mm - Embalagem 11 réguas – 2,51 m²

CHANFRO 0



CLASSE AC4



00001 1200



Novo Carvalho Everest
QSSM 0314



Carvalho Natural Envernizado
QSSM 1292



Carvalho Natural Midnight
QSSM 1487



Carvalho Escuro Midnight
QSSM 1488



Miracosa Jersey
QSSM 1533



Carvalho Natural Havana
com Marcas de Serra
QSSM 1656



Carvalho Vanilla
QSSM 2676



Pátina Cottage
QSSM 5001



PREMIERE+

Com grande variedade de cores, a linha Premiere+ transforma seu ambiente, combinando design, qualidade e economia*.

- ✓ 18 ANOS USO RESIDENCIAL
- ✓ 5 ANOS USO COMERCIAL



PREMIERE

1200 x 215 x 7 mm - Embalagem 11 réguas = 2,84 m²

CHANFRO 0

UNICLIC

CLASSE AC4





Carvalho Sacramento
QPRP 034



New Pegasus
QPRP 0316



Malta
QPRP 1067



Essencial Oak
QPRP 1577



Mocha
QPRP 3044



Ipê Ábano
QPRP 8005





Mantas, Rodapés e Acessórios

Procuo uma
solução econômica



STANDARD QS



Uma base de boa
qualidade
para locais com
menos
tráfego como,
por exemplo,
um dormitório.

Espessura: 2 mm
Rolo = 20,4 m²



- ✓ Proteção contra umidade
- ✓ Efeito de nivelamento

Quero diminuir o tempo
gasto na instalação
e o ruído
refletido



UNISOUND



Ideal para locais com
tráfego frequente
como,
por exemplo, uma
sala
de estar.

Espessura: 2 mm
Rolo = 15 m²



- ✓ Proteção contra umidade
- ✓ Efeito de nivelamento

Uma manta Quick-Step para cada situação

A manta é uma **necessidade absoluta** na instalação de um **piso**. O uso da manta correta tem um impacto importante no aspecto final, na qualidade e no conforto proporcionado pelo seu piso laminado Quick-Step. **As mantas de alta qualidade são fáceis de instalar, criam uma base nivelada para o seu novo piso e oferecem excelente isolamento térmico e acústico.** As mantas Quick-Step proporcionam uma base estável que protege os sistemas Uniclic® e Uniclic® Multifit. Além disso, elas garantem proteção contra a umidade que pode subir do contrapiso.

RODAPÉ MIDI
240X6X1,5 CM
Apenas para Linha Premiere



RODAPÉ BORDER
240X8X1,8 CM
Exceto Linha Premiere



CANTONEIRA
240X2X2 CM
Exceto Linha Impressive



1 Cores que combinam

A Quick-Step oferece rodapés nas cores correspondentes a cada piso.

2 Uma ampla variedade de

opções, a Quick-Step tem uma ampla variedade de rodapés e perfis, com diferentes alturas e larguras.

3 Resistência a riscos

Os rodapés da Quick-Step são resistentes a riscos e protegidos contra o desgaste do dia a dia, e contam com a mesma garantia dos pisos.





RODAPÉ MIDI BRANCO
240X 6 X1,5 CM

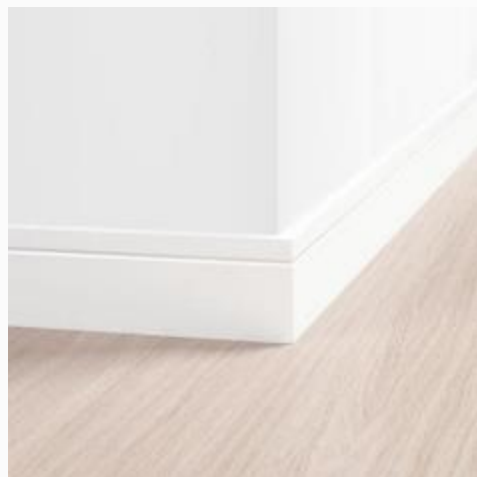

RODAPÉ NOBLE BRANCO
240X10X1,8 CM

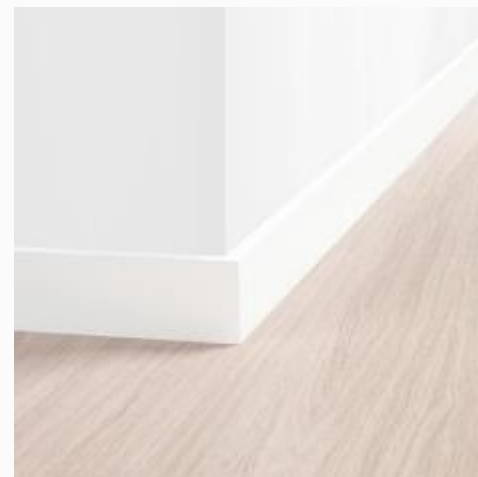

RODAPÉ BORDER BRANCO
240X8X1,8 CM



CANTONEIRA (EXCETO IMPRESSIVE)
240X2X2 CM



RODAPÉ COVER BRANCO
240X12,7X1,8 CM

O rodapé Cover branco possui a tecnologia Incizo®, facilmente cortado na altura desejada (graças às várias linhas de pré-corte feitas na fábrica).

O rodapé Cover pode ser usado para cobrir rodapés de cerâmica com alturas entre 4 a 10 cm e espessuras entre 8 a 10 mm.



RODAPÉ COVER BRANCO



Opções de cobertura rodapé COVER 2400X127X18 mm, para rodapé cerâmico;

1ª opção sem desmembrar o rodapé COVER 127 mm - rodapé cerâmico altura máxima 100 mm espessura máxima 8 mm.

2ª opção, desmembrando a primeira face rodapé COVER 107 mm - rodapé cerâmico altura máxima 80 mm espessura máxima 8 mm.

3ª opção, desmembrando a segunda face rodapé COVER 87 mm - rodapé cerâmico altura máxima 60 mm espessura máxima 9 mm.

4ª opção, desmembrando a terceira face rodapé COVER 67 mm - rodapé cerâmico altura máxima 40 mm espessura máxima 10 mm.





O perfil **Incizo**[®] da Quick-Step é uma ferramenta **multifuncional de acabamento** que pode ser usada para dar o acabamento a seu piso ou sua escada, em cores que combinam perfeitamente. Simplesmente corte o perfil básico Incizo[®] no formato adequado, utilizando para isso o cortador Incizo[®] fornecido.





Para garantir o melhor acabamento ou transição na colocação do seu piso, desde 2016 a Quick-Step, única empresa do mercado a produzir perfis de HDF, oferece e recomenda a você o uso do perfil de transição Incizo® a cada 13 metros lineares (13x13m)*, totalizando uma área de 169m².

Isso porque, comparado a qualquer outro, os perfis de transição Incizo® são os que **apresentam os menores relevos de HDF do mercado, além de combinarem perfeitamente com o desenho dos pisos laminados Quick-Step, garantindo mais elegância, beleza e harmonia no resultado final.**



APLICAÇÃO 1
Conectar dois pisos
com alturas diferentes.



APLICAÇÃO 2
Conectar dois pisos
com a mesma altura.



APLICAÇÃO 3
Dar acabamento a seu
piso junto a paredes
ou janelas.



APLICAÇÃO 4

Criar uma transição
harmoniosa entre seu piso
laminado e outros tipos de piso.



APLICAÇÃO 5

O perfil Incizo® também permite fazer o acabamento em escadas com o design de sua preferência.

Para esta aplicação específica você precisará utilizar o perfil Incizo® e um subperfil de alumínio.

Subperfil de alumínio Incizo para escadas (215 x 7,1 x 1,7 cm). A ser encomendado separadamente, incluindo a tira de plástico.

O acabamento de escadas com o perfil Incizo não pode ser utilizado em aplicações comerciais.



PERFIL MULTIFUNCIONAL

186 x 4,7 x 1 cm

Conteúdo: 1 perfil I multifuncional, 1 base de encaixe de plástico

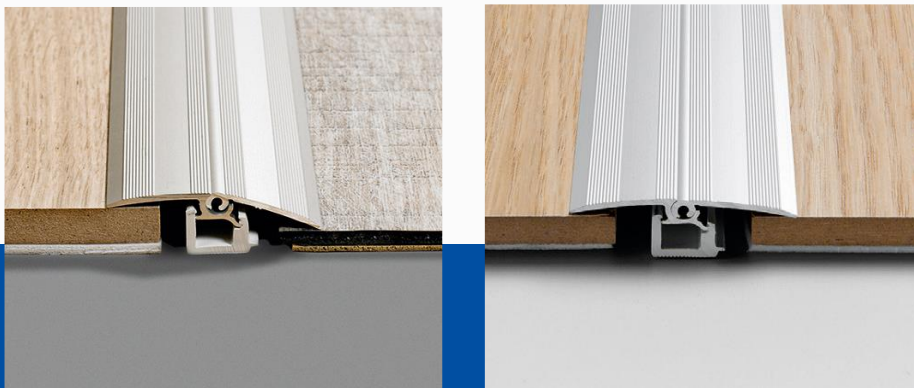

Perfil de alumínio resistente a riscos para conectar pisos com diferença de altura entre 0 e 12,3 mm. A ser utilizado, por exemplo, entre dois pisos laminados Quick-Step ou entre um piso laminado e outro piso mais alto ou mais baixo. Somente disponível na cor prata. Uso residencial.

PERFIL METÁLICO

270 x 4,8 x 1,2 cm

Contém: 1 perfil I Incizo® metal, 1 cortador, 1 base de encaixe de plástico.



Com o cortador, você pode criar o perfil desejado. Não utilizar em escadas. Disponível em alumínio, nas cores prata, ouro ou bronze. Também disponível para aplicações comerciais com trilho metálico, parafusos e buchas.





Acabamento para áreas úmidas
| Impressive | Eligna Wide | Vision |
| Smart | Classic



Para um acabamento perfeito em **áreas úmidas e permanência da garantia**, é necessário utilizar o Hydrokit, só ele garante a selagem completa na instalação dos acabamentos.

1. Utilizar a Manta Standard QS ou Unisound .

2. Colocar tira de espuma (8 a 10 mm) na fresta de expansão.

3. Selar com Hydrokit.

4. Colocar o acabamento.

5. Selar o acabamento.

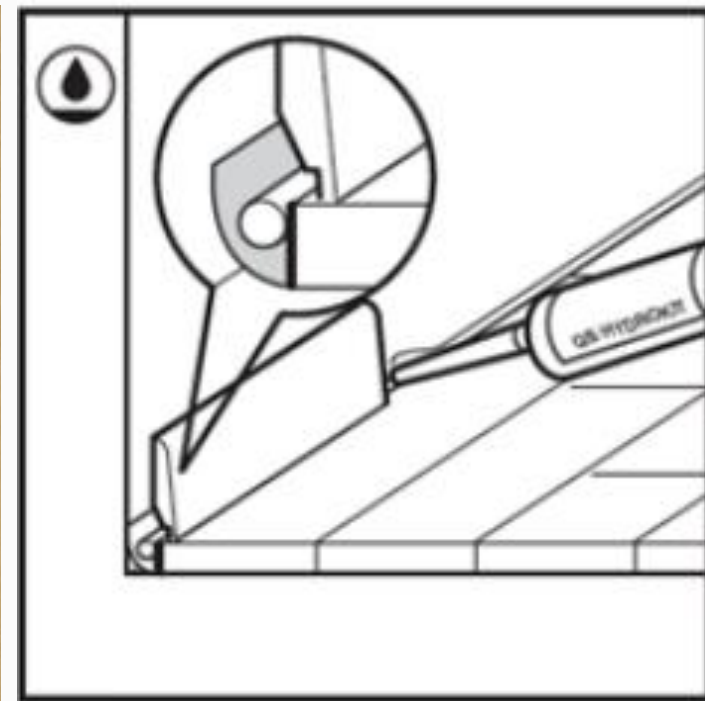

O Hydrokit Quick-Step é um silicone transparente que proporciona um acabamento impermeável e invisível para rodapés, perfis, etc.

RECOMENDAÇÃO DE REMOÇÃO DE ÁGUA:



LINHA VISION

Até 100 horas de resistência à água.

LINHA IMPRESSIVE, ELIGNA WIDE E CLASSIC

Até 72 horas de resistência à água.

LINHA SMART

Até 48 horas de resistência à água.



PISOS VINÍLICOS

Resistentes, silenciosos e confortáveis



O visual que você deseja, com o conforto que você precisa

Silencioso, resistente e 100% impermeável

Desfrute de seu piso vinílico por muitos anos, graças à camada protetora selada, com as tecnologias :

Essa película garante **uma proteção superior contra riscos, manchas, sujeira e marcas de sapatos**. E mais: graças à sua excelente resistência à água, nossos sofisticados pisos vinílicos **são a escolha ideal para qualquer ambiente, até mesmo banheiros e cozinhas**.

A camada protetora hidro-repelente faz com que sejam super fáceis de limpar. É muito gostoso caminhar sobre esses pisos quentes e confortáveis, mesmo com os pés descalços. Prefere ficar com seus sapatos? **Todos os pisos vinílicos são silenciosos: não se ouve quase nada**.



<https://www.youtube.com/watch?v=j7SUNzq1T9E>

Uma grande variedade de lindos designs e de aparência natural

A coleção de pisos vinílicos da Quick-Step apresenta uma ampla variedade de **designs com a aparência de madeira natural**, cada um com suas próprias características autênticas.





QUAL A COMPOSIÇÃO DO PISO VINÍLICO QUICK-STEP?

O piso vinílico Quick-Step é um piso composto por camadas construído em torno de uma placa de **PVC**.



FLEXÍVEL

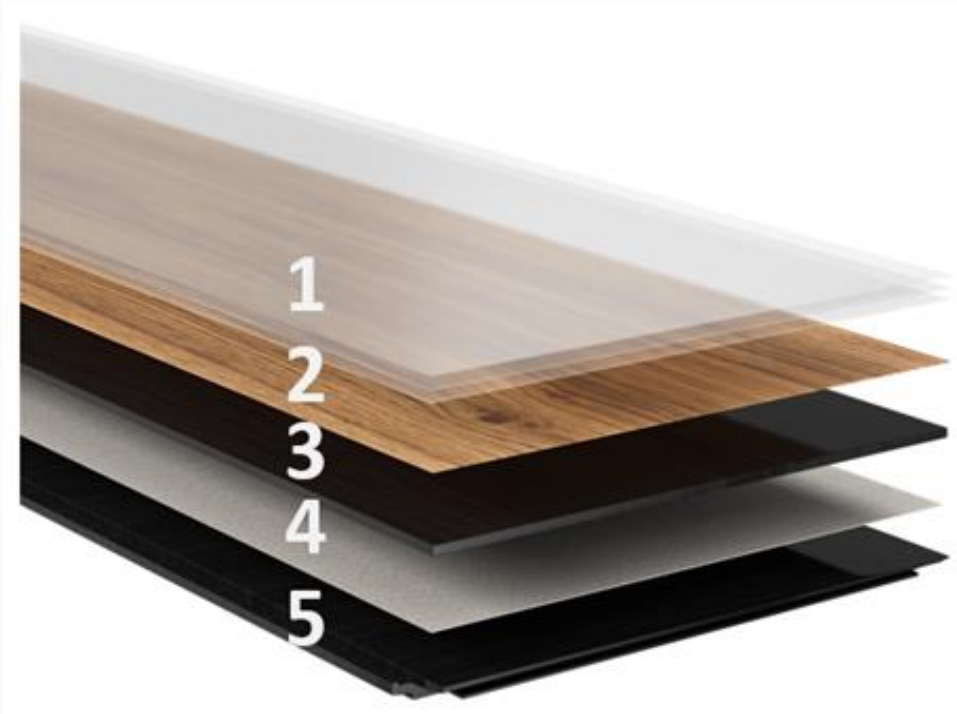

1. Camada de desgaste de alto desempenho;
2. Papel decorativo com impressão em alta resolução do padrão;
3. Placa de PVC altamente resistente a impactos;
4. Camada estabilizadora, contendo fibra de vidro;
5. Camada extra de PVC, altamente resistente a impactos.



RÍGIDO (SPC)



1. Cobertura UV: para resistência aos riscos e manchas;
2. Capa de uso: camada de desgaste de alto desempenho;
3. Decorativo: papel decorativo com impressão do padrão;
4. Núcleo PVC: placa rígida de PVC para alta resistência ao impacto e baixa endentação;
5. Manta acoplada: camada de IXPE para facilitar a instalação.

Os pisos **vinílicos rígidos** se referem principalmente aos pisos **vinílicos SPC** (solid polymer core – núcleo de polímero sólido). Este tipo específico é NOVO no mercado e é em essência um LVT com Upgrade de núcleo rígido forte.



Muito resistente a impactos

Baixa indentação

Sem telegrafia (fácil de instalar em contra pisos irregulares ou existentes como cerâmica)

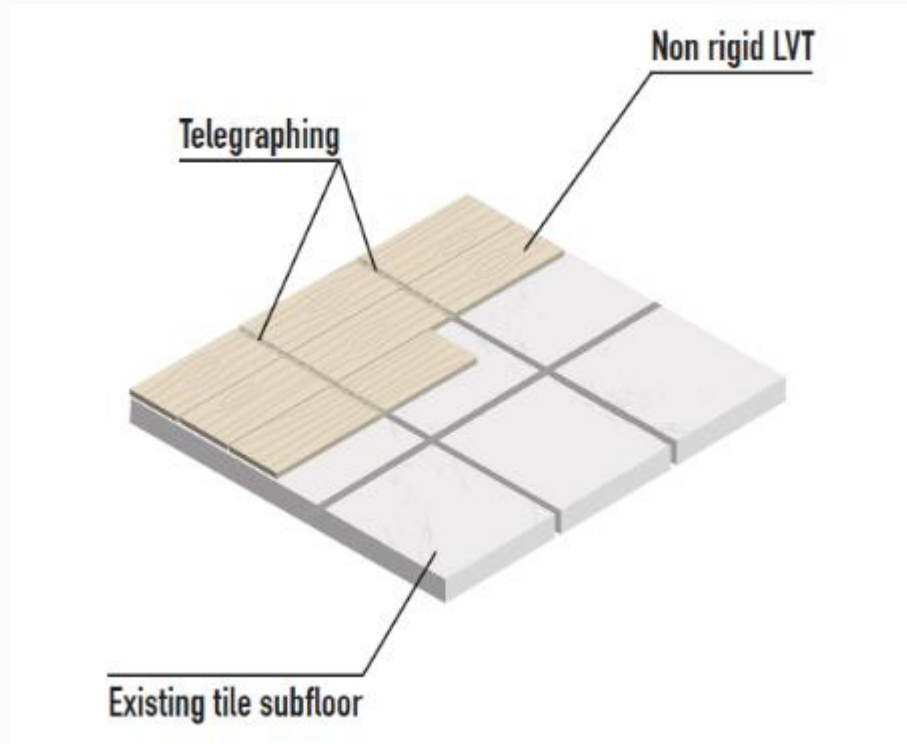



COMO SÃO CLASSIFICADOS



Classificação de acordo com as áreas de uso

Áreas consideradas para uso residencial

21



MODERADO – DORMITÓRIOS

22



GERAL – ESTAR E HALL DE ENTRADA

23



PESADO – ESTAR E HALL DE SERVIÇOS E COZINHAS

Áreas consideradas para uso comercial

31

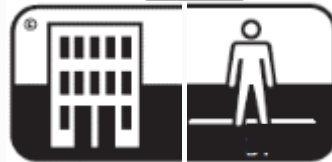

MODERADO – DORMITÓRIOS, QUARTOS DE HOTÉIS, SALAS DE CONFERÊNCIA E PEQUENOS ESCRITÓRIOS

32



GERAL - SALAS DE AULA, ESCRITÓRIOS, HOTÉIS E PEQUENAS LOJAS

33

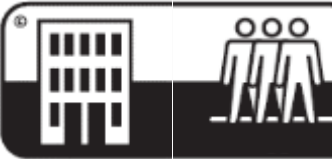

PESADO - CORREDORES, LOJAS DE DEPARTAMENTO, ESCOLAS, SAGUÕES, GRANDES ESCRITÓRIOS, CLÍNICAS, HOTÉIS

34



MUITO PESADO – AEROPORTOS, SAGUÕES, LOJAS DE DEPARTAMENTO, HOSPITAIS, CLÍNICAS E HOTÉIS

Áreas consideradas para uso industrial

41

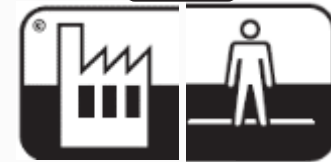

MODERADO – MONTAGENS ELETRÔNICAS, ENGENHARIA DE PRECISÃO

42

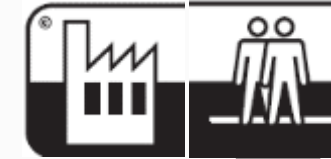

GERAL – COM MOVIMENTAÇÃO DE VEÍCULOS, DEPÓSITO E MONTAGENS ELETRÔNICAS

43

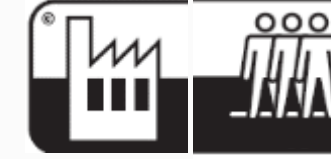

PESADO – DEPÓSITOS E SALAS DE PRODUÇÃO

VINÍLICOS

COLEÇÃO 2024

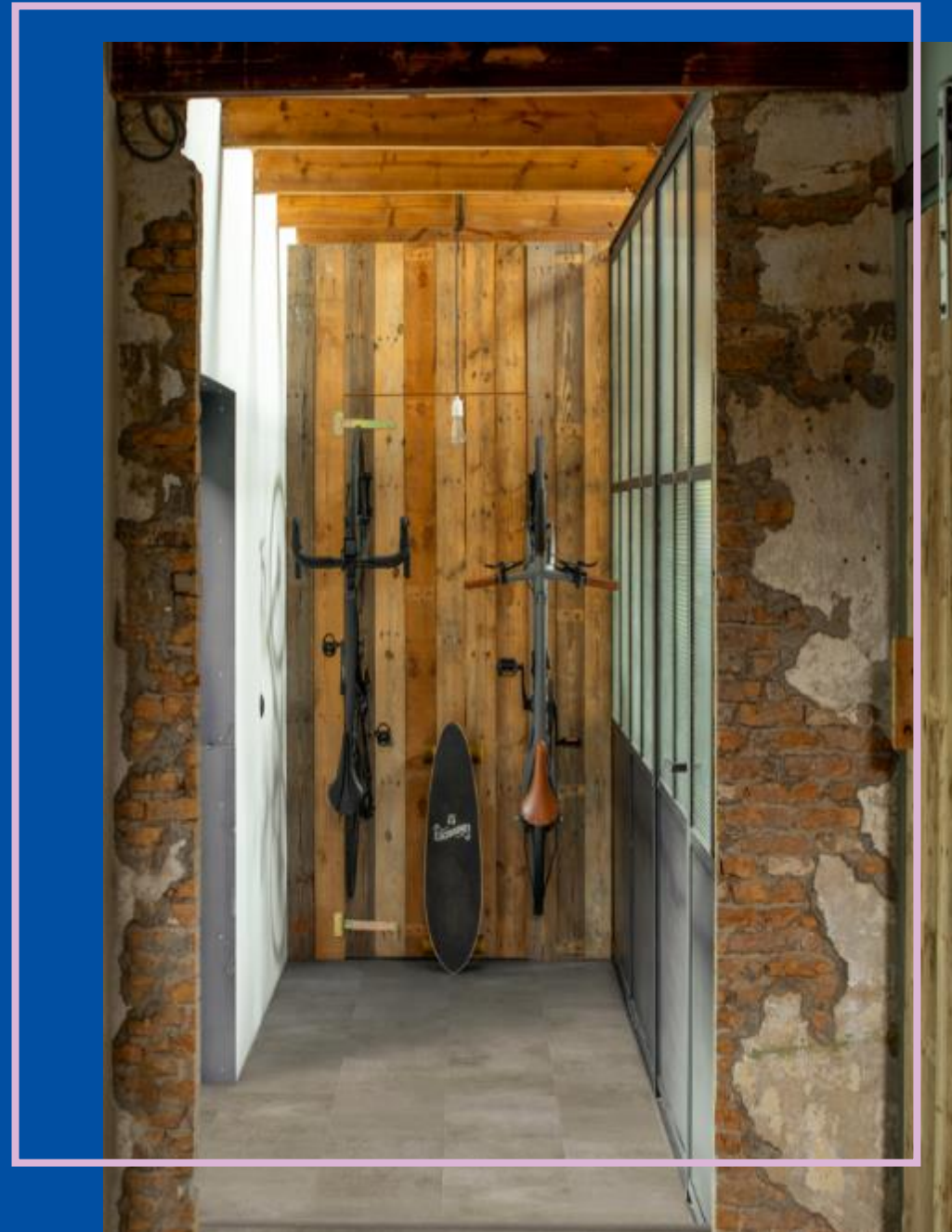

Coleção 2023 - Vinílico

RÉGUAS			DIMENSÕES	EMBALAGEM	CHANFRO	CAPA DE USO	CLASSE	INSTALAÇÃO	GARANTIA
	INVENTO		1520 x 228 x 5 + 1 mm	6 réguas = 2,08 m ²		0,50 mm	CLASSE 32		✓ 20 ANOS RESIDENCIAL ✓ 5 ANOS COMERCIAL
	VIVRE		1220 x 180 x 4 + 1 mm	10 réguas = 2,20 m ²		0,30 mm	CLASSE 31		✓ 20 ANOS RESIDENCIAL ✓ 5 ANOS COMERCIAL*
	MARES		1227 x 187 x 2,5 mm	18 réguas = 4,13 m ²		0,50 mm	CLASSE 32		✓ 20 ANOS RESIDENCIAL ✓ 5 ANOS COMERCIAL

PLACAS			DIMENSÕES	EMBALAGEM	CHANFRO	CAPA DE USO	CLASSE	INSTALAÇÃO	GARANTIA
	INVENTO		915 x 470 x 5 + 1 mm	4 placas = 1,72 m ²		0,50 mm	CLASSE 32		✓ 20 ANOS RESIDENCIAL ✓ 5 ANOS COMERCIAL
	VIVRE		600 x 310 x 4 + 1 mm	12 placas = 2,23 m ²		0,30 mm	CLASSE 31		✓ 20 ANOS RESIDENCIAL ✓ 5 ANOS COMERCIAL*



INVENTO RÉGUAS

O design da Linha Invento impressiona pela beleza natural, levando mais estilo aos ambientes, enquanto a inovação permite instalação prática sobre todos os tipos de superfícies.

- ✓ 20 ANOS USO RESIDENCIAL
- ✓ 5 ANOS USO COMERCIAL



INVENTO RÉGUAS

1520 x 228 x 5 + 1 mm - Embalagem 6 réguas = 2,08 m²

CHANFRO 

CAPA DE USO = 0,50 mm

CLASSE 32





Nikola
QSIR 501



Alexander
QSIR 502



Isaac
QSIR 503



Galileo
QSIR 504



Thomas
QSIR 505



Marie
QSIR 506



Carvalho Bege Canyon
BACP 40038



Carvalho Marrom Claro
Canyon com Cortes de Serra
BACP 40031



INVENTO PLACAS

De fácil instalação, a linha de placas Invento leva mais do que elegância aos ambientes: oferece conforto acústico e maior estabilidade, qualidades em sintonia com o bem-estar necessário para aqueles que fazem história.

- ✓ 20 ANOS USO RESIDENCIAL
- ✓ 5 ANOS USO COMERCIAL



INVENTO PLACAS

915 x 470 x 5 + 1 mm - Embalagem 4 placas = 1,72 m²

CHANFRO 

CAPA DE USO = 0,50 mm

CLASSE 32





Stephanie
QSIP 509



Santos
QSIP 511



Hedy
QSIP 510



Alfred
QSIP 512

VIVRE RÉGUAS

Um espírito livre vive sempre rodeado por oportunidades que não deixam escapar a felicidade. A elegância da Linha Vivre contribui para um ambiente de beleza que inspira as melhores energias.

- ✓ 20 ANOS USO RESIDENCIAL
- ✓ 5 ANOS USO COMERCIAL*



VIVRE RÉGUAS

1220 x 180 x 4 + 1 mm - Embalagem 10 réguas - 2,20 m²

CHANFRADO 

CAPA DE USO = 0,30 mm

CLASSE 31





Lyon
QSVR 401



Marseille
QSVR 402



Nantes
QSVR 403



Provence
QSVR 404



Lille
QSVR 405



Dijon
QSVR 406



Versailles
QSVR 407



St-Tropez
QSVR 408



VIVRE PLACAS

Uma linha que impressiona pelo aconchego,
sem abrir mão do estilo que a sua casa merece.

- ✓ 20 ANOS USO RESIDENCIAL
- ✓ 5 ANOS USO COMERCIAL*



VIVRE PLACAS

600 x 310 x 4 + 1 mm - Embalagem 12 placas - 2,23 m²

CHANFRO 

CAPA DE USO - 0,30 mm

CLASSE 31





Strasbourg
QSVP 409



Normandie
QSVP 411



Avignon
QSVP 410

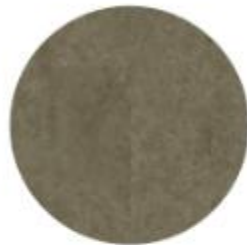

Bretagne
QSVP 412

MARES

Belezas que chegam com inspiração nos mares se unem à tecnologia em uma linha de pisos pronta para os mais diferentes tipos de projetos.

- ✓ 20 ANOS USO RESIDENCIAL
- ✓ 5 ANOS USO COMERCIAL



MARES

1227 x 187 x 2,5 mm - Embalagem 18 réguas = 4,13 m²

CHANFRADO 

CAPA DE USO = 0,50 mm

CLASSE 32



Egeu
QSMR 251



Adriático
QSMR 252



Celta
QSMR 253



Jônico
QSMR 254



Bering
QSMR 255



Mediterrâneo
QSMR 256



Báltico
QSMR 257



Pérsico
QSMR 258



A modern living room with a grey sofa, a small metal table, and a blue overlay with text. The room features a grey sofa, a small metal table with a glass and a bottle, a blue beanbag chair, a potted plant, and a desk lamp. The text "Tenha um acabamento perfeito" and "Acessórios" is overlaid on a blue background.

Tenha um acabamento perfeito
Acessórios

Perfis de acabamento de alumínio

PERFIL TRANSIÇÃO

2.000 x 5 x 26 mm

Para uso comercial*



PERFIL REDUTOR

2.000 x 7 x 24 mm

Para uso comercial*



PERFIL TERMINAL

2.000 x 7 x 18 mm

Para uso comercial*

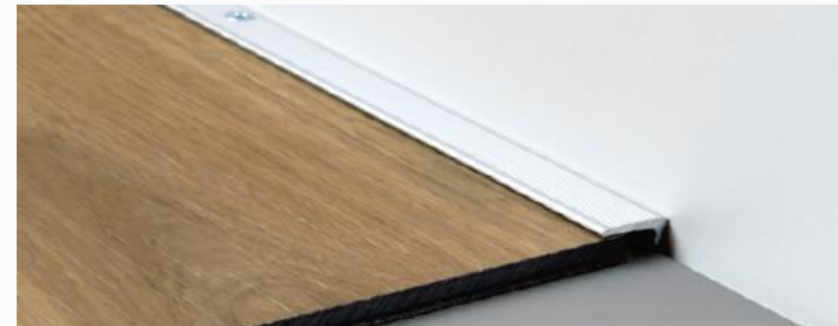

PERFIL MULTIFUNCIONAL PRATA

1860 x 47 x 12,3 mm

Para uso residencial**

Acomoda diferenças de nível de até 12,3 mm e pode ser utilizado como perfil adaptador ou perfil de expansão.





LIMPEZA E MANUTENÇÃO

Mantenha seu piso em perfeitas condições

PRODUTO DE LIMPEZA

1.000 ml

Os produtos de limpeza foram desenvolvidos especificamente para os pisos da Quick-Step. Limpam profundamente a superfície do piso e conservam seu aspecto original sem deixar camadas residuais do produto.

KIT DE LIMPEZA

Conteúdo: um suporte com cabo ajustável, pano de microfibra lavável, produto de limpeza da Quick-Step (1.000 ml).





QUAIS AS PRINCIPAIS DIFERENÇAS ENTRE O PISO VINÍLICO E O LAMINADO?



LAMINADO



Madeira de
Reflorestamento HDF



Instalação rápida sem
preparação prévia



Instalação sem
sujeira



Fácil limpeza e
manutenção

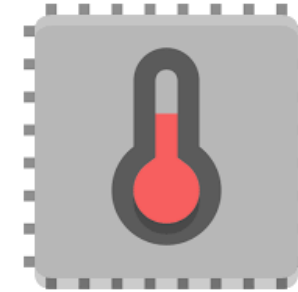

Conforto térmico



Compatível com
sistema de
aquecimento

VINÍLICO



Material reciclável



Instalação com
preparação prévia



Conforto acústico



Fácil limpeza e
manutenção

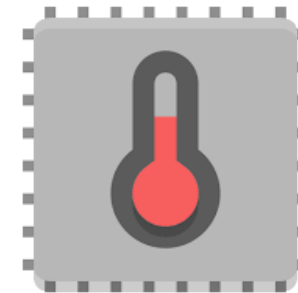

Conforto térmico

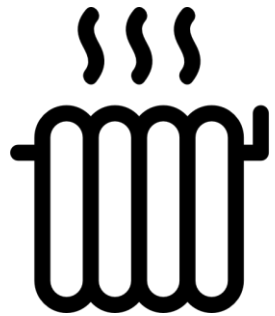

Compatível com
sistema de
aquecimento



SIGA-NOS:



@quickstep_brasil / www.instagram.com/quickstep_brasil



[www.facebook.com / quickstepbrasil](https://www.facebook.com/quickstepbrasil)



Quick-Step Brasil goo.gl/bcUGfV